

Maße
Dimensions
Encombremet • Dimensioni
Dimensiones • Габариты крана

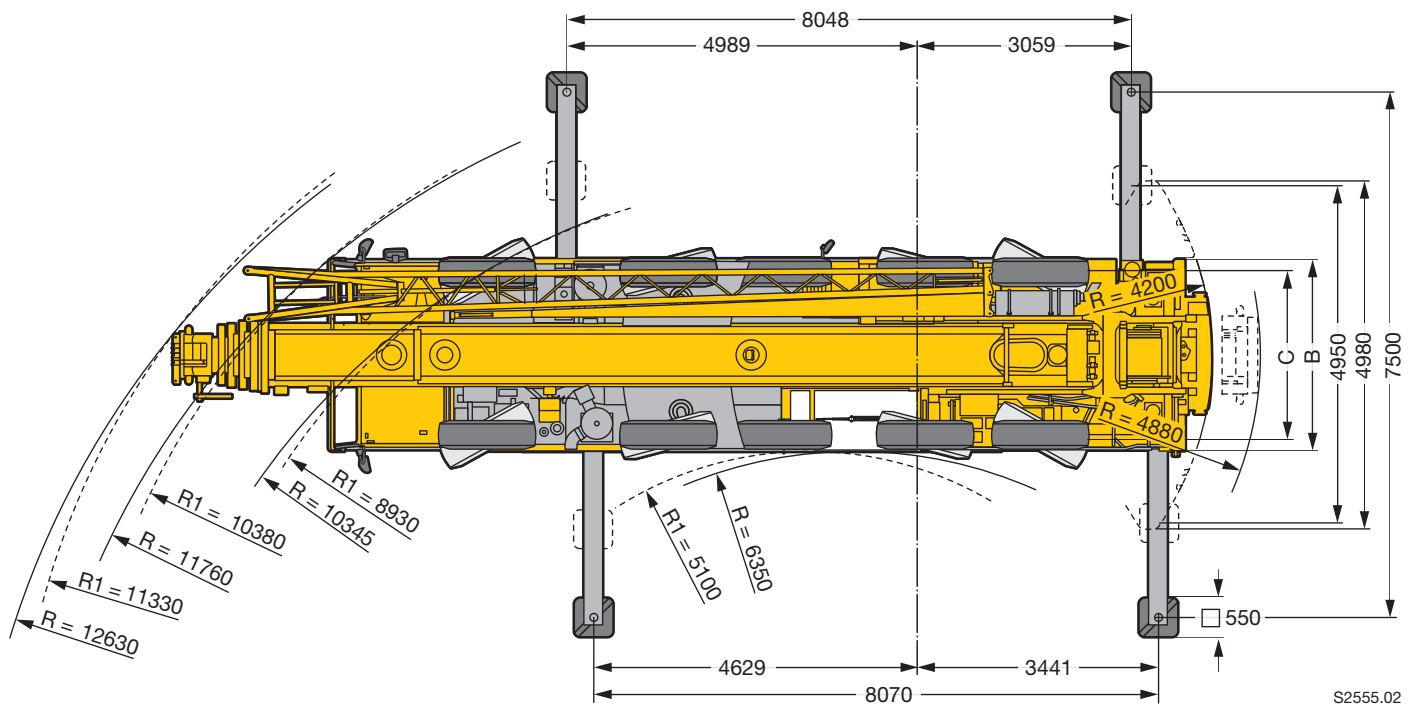
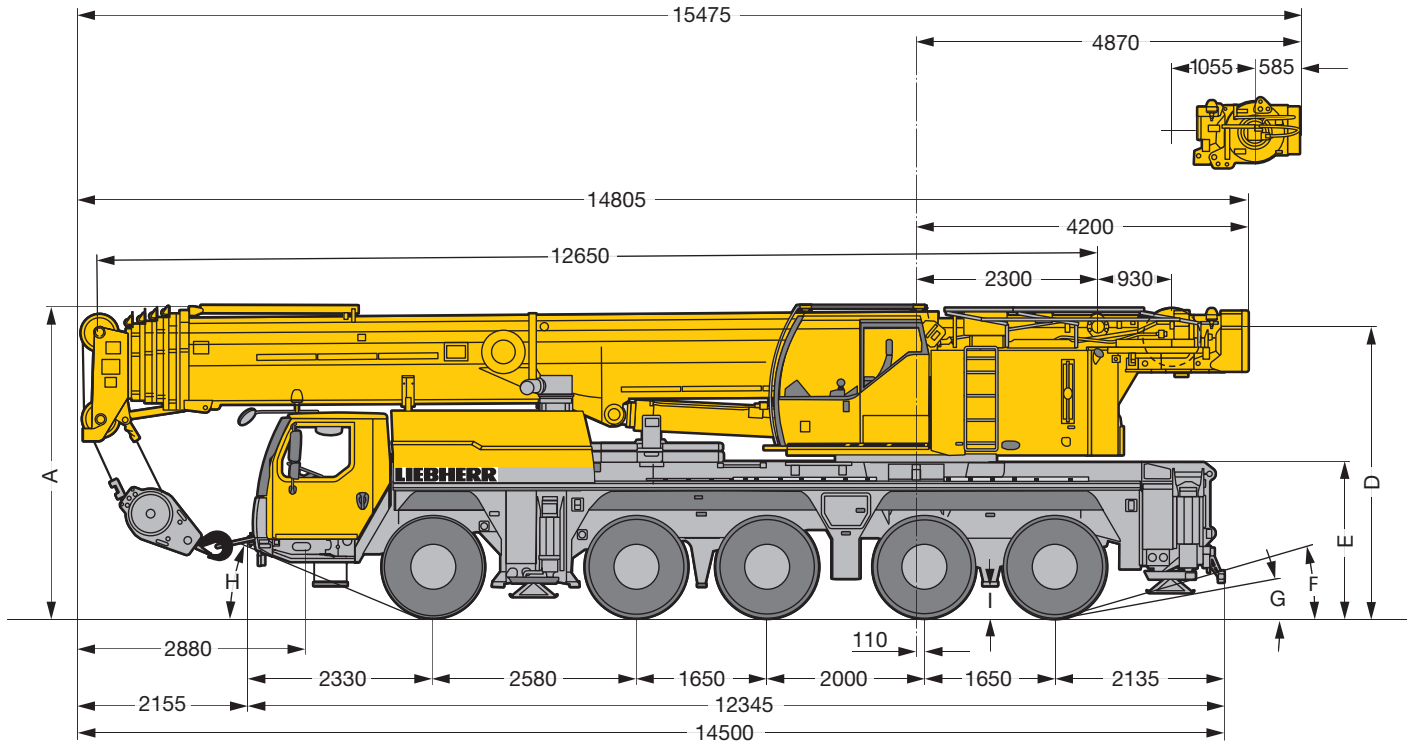

S2555.02

R₁ = Allradlenkung · All-wheel steering · Direction toutes roues · Tutti gli assi sterzanti · Dirección en todos los ejes · Поворот всеми колесами

	Maße · Dimensions · Encombremet · Dimensioni · Dimensiones · Размеры mm									
	A	A	B	C	D	E	F	G	H	I
		100 mm*								
385/95 R 25 (14.00 R 25)	3950	3850	2750	2313	3702	2000	19°	11°	23°	380
445/95 R 25 (16.00 R 25)	4000	3900	2750	2301	3752	2050	20°	13°	24°	430
525/80 R 25 (20.5 R 25)	4000	3900	2850	2323	3752	2050	20°	13°	24°	430

* abgeseckt · lowered · abaissé · abbassato · suspensión abajo · шасси осажено

Hubhöhen
Lifting heights
 Hauteurs de levage • Altezze di sollevamento
 Alturas de elevación • Высота подъема

T

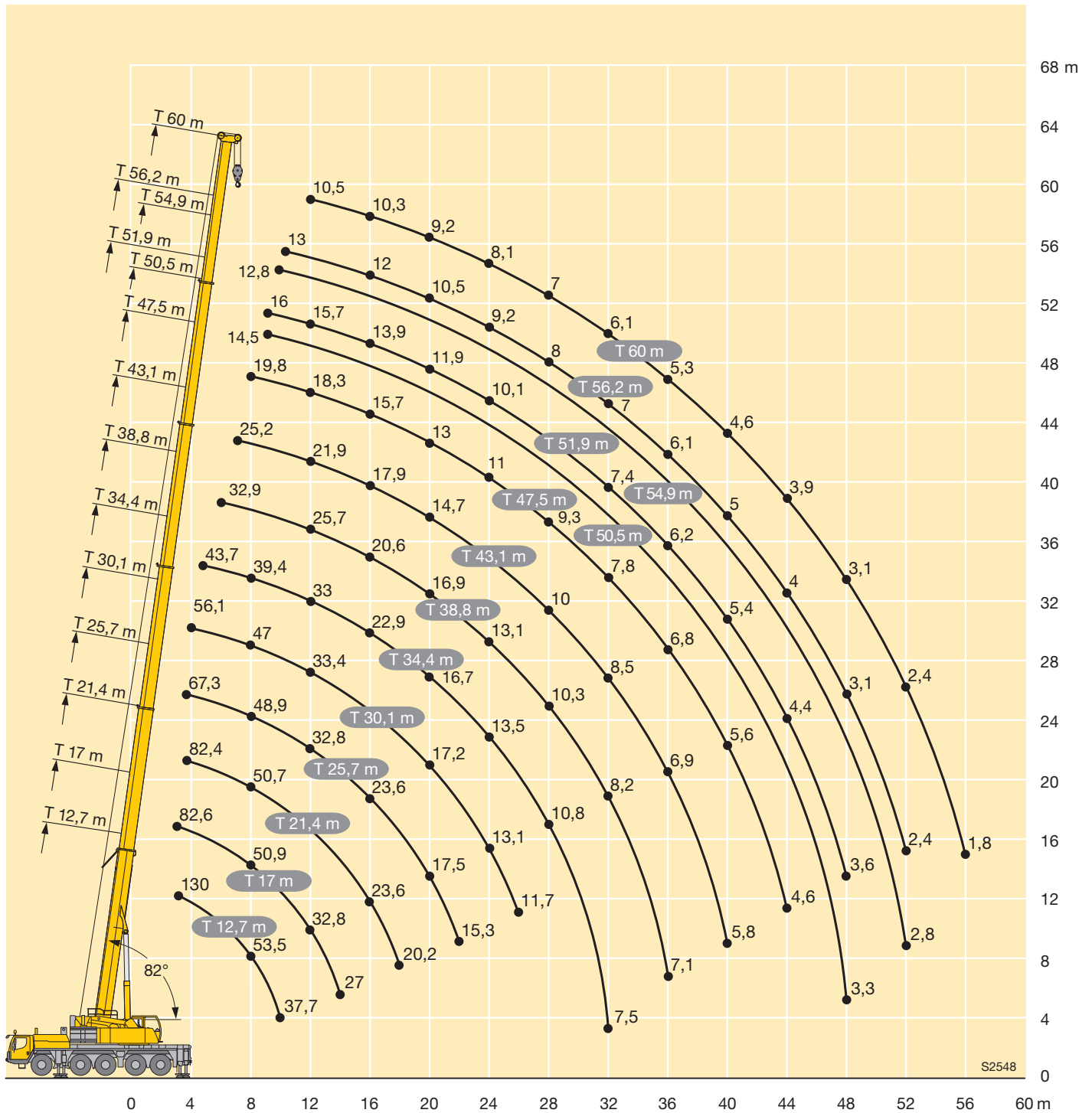

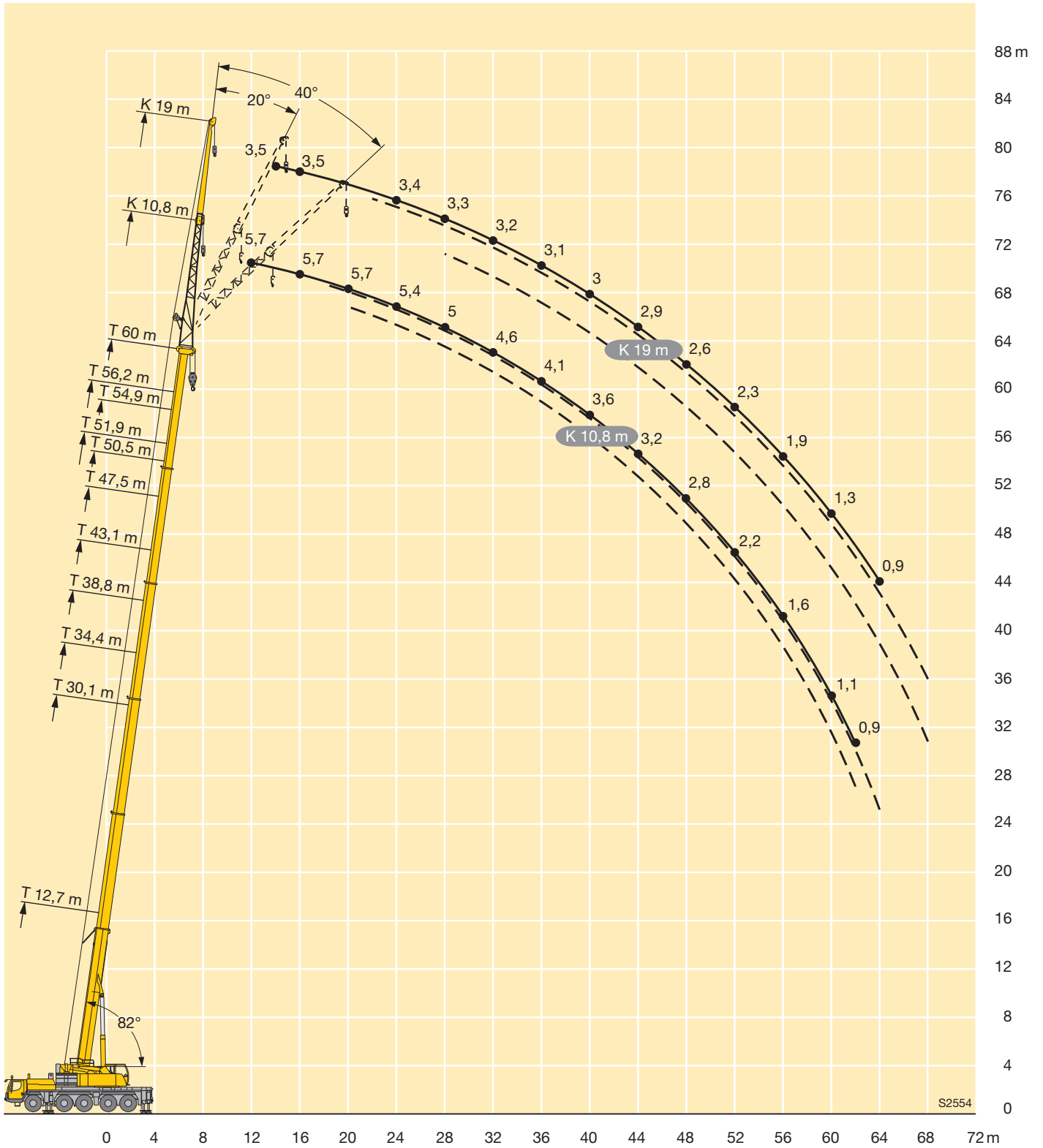

S2554

Hubhöhen
Lifting heights

Hauteurs de levage · Altezze di sollevamento
Alturas de elevación · Высота подъема

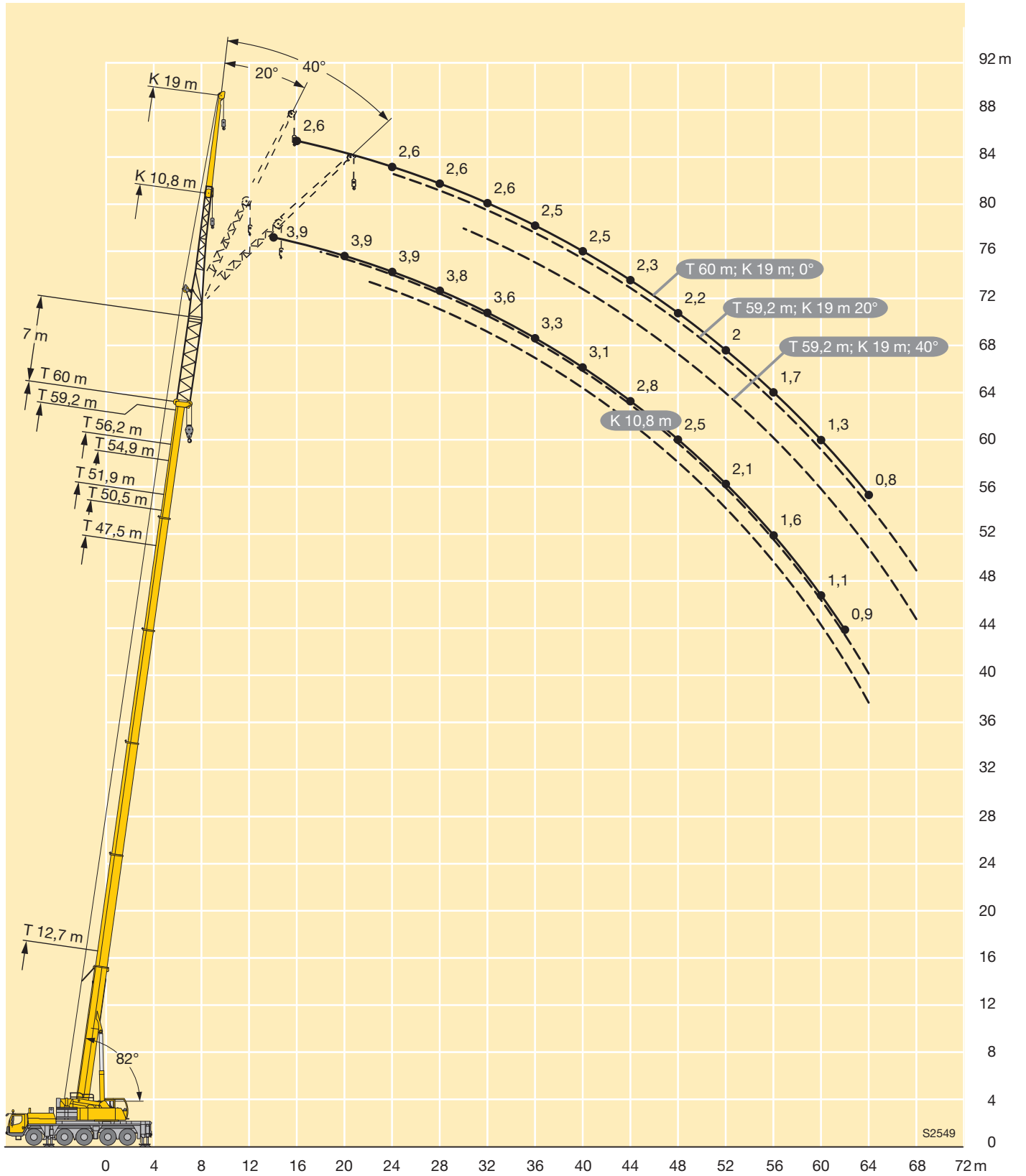

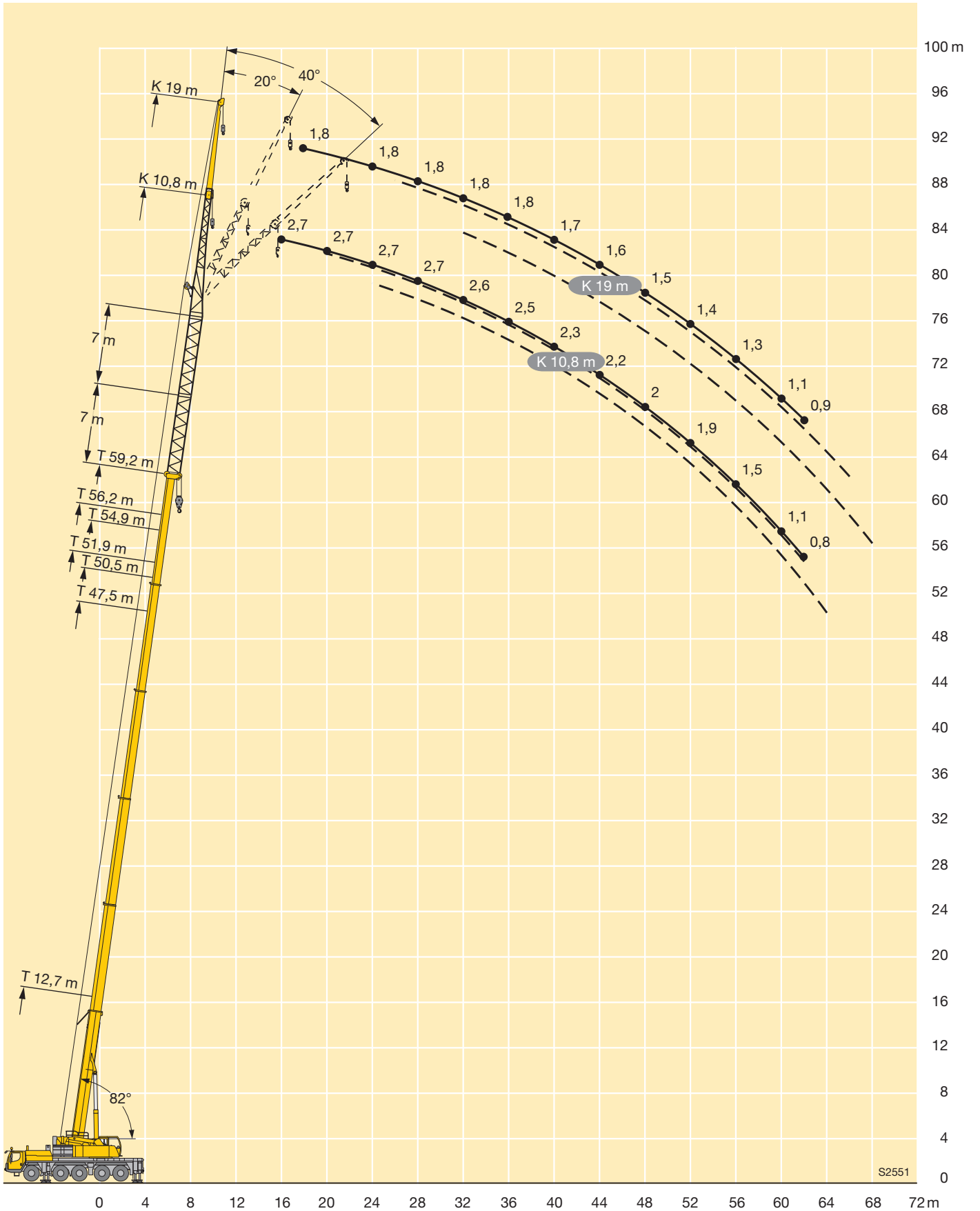

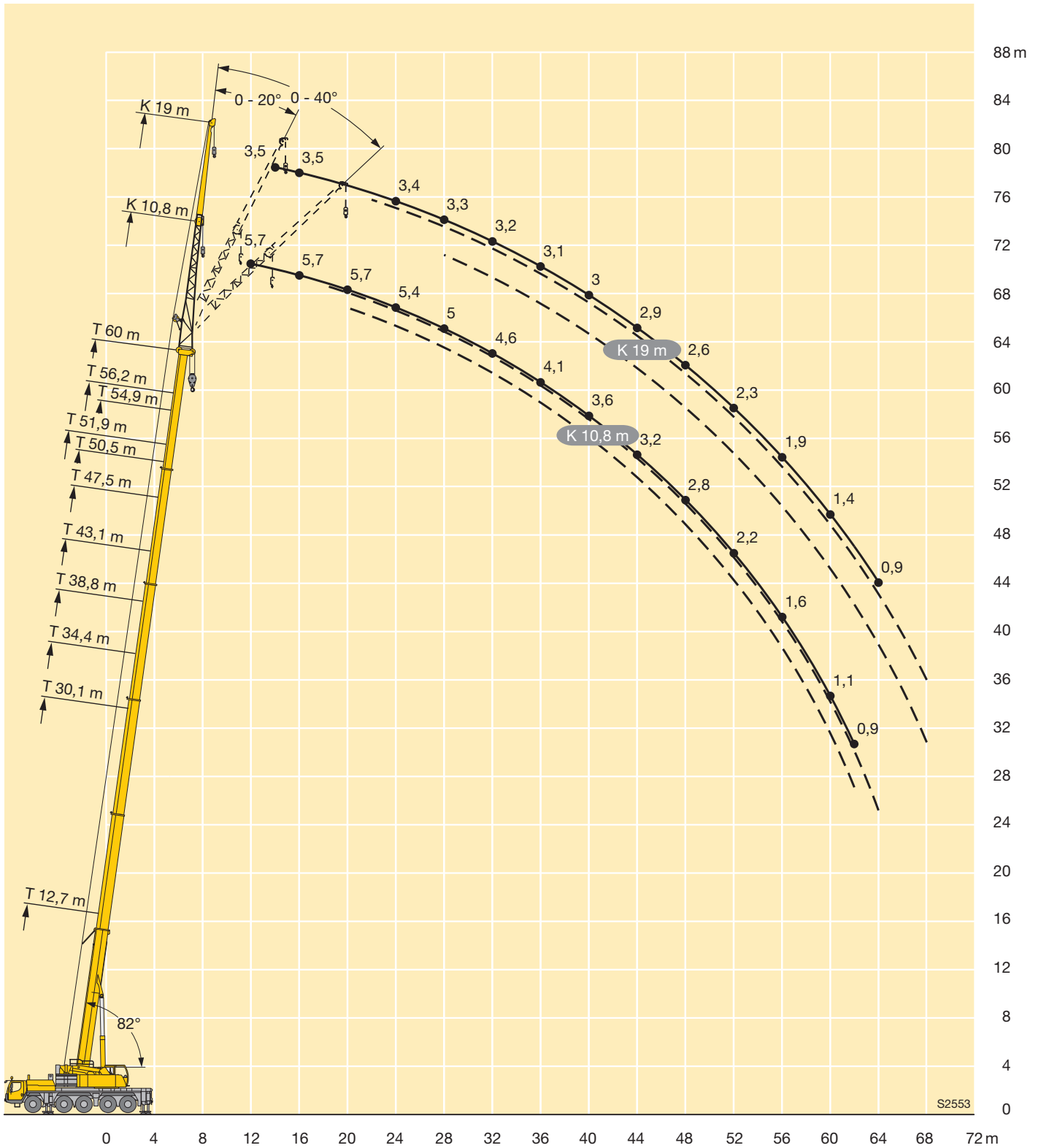

Hubhöhen
Lifting heights

Hauteurs de levage · Altezze di sollevamento
Alturas de elevación · Высота подъема

TVNZK

